

NEUHEITEN
EXPRESS

★
2. AUSGABE 2023
SEPTEMBER

PREMIERE FÜR 18 BRANDNEUE MODELLE!



BRAWA
LIEBE ZUM DETAIL



CITY-BAHN OHNE STAU IM STUNDENTAKT

Um den Nahverkehrszug abzulösen und Nebenstrecken attraktiver zu machen, führte die Deutsche Bundesbahn (DB) zum Fahrplanwechsel am 30. September 1984 die neue Zugattung City-Bahn ein. Unter dem Motto „City-Bahn – Ohne Stau im Stundentakt“ wurde ein dichter Taktfahrplan eingeführt und vorhandene n-Wagen hierfür modernisiert.

Die stilllegungsgefährdete Strecke Köln–Overath–Gummersbach–Meinerzhagen war die erste Verbindung mit diesem Angebot. Die 25 n-Wagen, davon sieben Steuerwagen, erhielten eine moderne Inneneinrichtung und wurden analog zu der S-Bahn Rhein-Ruhr reinorange/kieselgrau lackiert. Erweitert wurden die Garnituren durch ein Café.



Nahverkehrswagen ABnrzb⁷⁷² „City-Bahn“ der DB
Betriebs-Nr. 50 80 31-34 025-2

Best.-Nr. 46640 UVP* 84,90 EUR	=				Best.-Nr. 46644 UVP* 104,90 EUR	=			
					Best.-Nr. 46648 UVP* 109,90 EUR	~			



LIEFERTERMIN: Q4/2023

Nahverkehrswagen Bnrzb^{778.1} „City-Bahn“ der DB
Betriebs-Nr. 50 80 22-34 064-2

Best.-Nr. 46641 UVP* 84,90 EUR	=				Best.-Nr. 46645 UVP* 104,90 EUR	=			
					Best.-Nr. 46649 UVP* 109,90 EUR	~			



LIEFERTERMIN: Q4/2023





Nahverkehrswagen Bnrzb^{778.1} „City-Bahn“ der DB
 Betriebs-Nr. 50 80 22-34 060-0

Best.-Nr. 46642 UVP* 84,90 EUR		Best.-Nr. 46646 UVP* 104,90 EUR	
		Best.-Nr. 46650 UVP* 109,90 EUR	



LIEFERTERMIN: Q4/2023

Steuerwagen BDnrzb⁷⁸⁴ „City-Bahn“ der DB
 Betriebs-Nr. 50 80 82-34 295-9

Best.-Nr. 46643 ¹⁾ UVP* 119,90 EUR		Best.-Nr. 46647 ¹⁾ UVP* 139,90 EUR	
		Best.-Nr. 46651 UVP* 189,90 EUR	



LIEFERTERMIN: Q4/2023

¹⁾Die DC-Modelle des Steuerwagens müssen im Digitalbetrieb zwingend mit einem Funktionsdecoder, z. B. FH22-4 (Best.-Nr. 0018271.00), ausgestattet werden.



*

**IMMER BESTENS BELADEN.
FÜR ANHÄNGER SCHÖNSTER DETAILS**



Gedeckter Güterwagen G10 „Westfalia“ der DB

Betriebs-Nr. 114 225

Best.-Nr. **50788**



107,2



LIEFERTERMIN: Q4/2023

UVP* 45,90 EUR

- Vorbildgerechter Rahmenaufbau
- Präzise Nachbildung der Bretterfugen
- Achsstege und Räder aus Metall
- Mehrteilige Bremsanlage
- Extra angesetzte Signalhalter

- Bremsbacken in Radebene
- Durchbrochene Wagenkastenstützen
- Präzise Bedruckung und Lackierung
- Extra angesetzte Achslagerdeckel

Gedeckter Güterwagen Gmhs30 „Westfalia“ der DB

Betriebs-Nr. 222 062

Best.-Nr. **47999**



104,6



LIEFERTERMIN: Q4/2023

UVP* 47,90 EUR

Gedeckter Güterwagen G1r22 „Westfalia“ der DB

Betriebs-Nr. 192 041

Best.-Nr. **50488**



139,1



LIEFERTERMIN: Q4/2023

UVP* 52,50 EUR

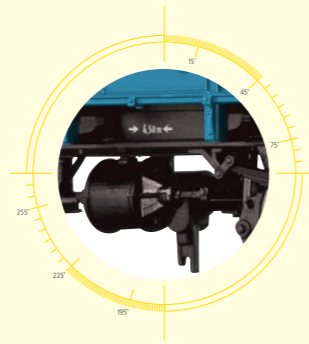
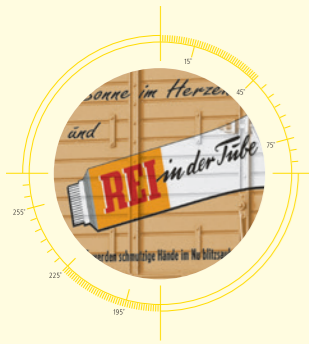



*
SO SCHÖN KANN
LIEBE ZUM DETAIL SEIN



Gedeckter Güterwagen G10 „Rei“ der DB

Betriebs-Nr. 121 615





Best.-Nr. **49753**    

LIEFERTERMIN: Q4/2023

UVP* 45,90 EUR

Gedeckter Güterwagen G „Bautz'ner“ der DR

Betriebs-Nr. 21 50 112 6153-8



Best.-Nr. **49714**    

LIEFERTERMIN: Q4/2023

UVP* 45,90 EUR

Gedeckter Güterwagen G „Julius Meisl“ der BBÖ

Betriebs-Nr. 512 087 [P]

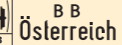



Best.-Nr. **48049**    

LIEFERTERMIN: Q4/2023

UVP* 59,90 EUR

Bierwagen G10 „Kaiser Bier“ der ÖBB

Betriebs-Nr. 560 072 [P]

Best.-Nr. **49891**    

LIEFERTERMIN: Q4/2023

UVP* 45,90 EUR

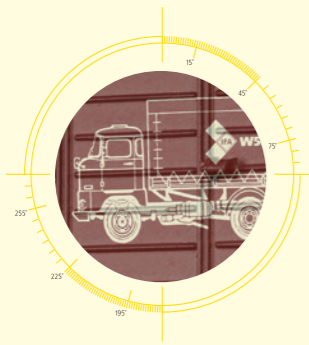
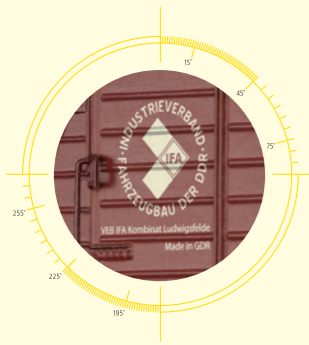

Gedeckter Güterwagen Gbs „IFA“ der DR

Betriebs-Nr. 01 50 151 2543-6

Best.-Nr. **49925**

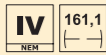

UVP* 54,90 EUR

LIEFERTERMIN: Q4/2023

Gedeckter Güterwagen Gbs „Leuna“ der DR

Betriebs-Nr. 44 50 155 9902-7 [P]

Best.-Nr. **49934**

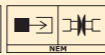
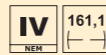

UVP* 54,90 EUR

LIEFERTERMIN: Q4/2023

Gedeckter Güterwagen Post2s-t/13 „Deutsche Bundespost“ der DR

Betriebs-Nr. 50 50 00-10 423-0

Best.-Nr. **49922**

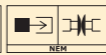

UVP* 54,90 EUR

LIEFERTERMIN: Q4/2023

- Räder aus Metall
- Extra angesetzte Signalhalter
- Extra angesetzte Achslagerdeckel
- Kurzkupplungskinematik nach NEM-Norm
- Metallachslager
- Mehrteilige Bremsanlage
- Bremsbacken in Radebene
- Vorbildgerechter Nachbau des Unterbodens



LEICHTBAUKESSELWAGEN UERDINGEN SCHWER BELADEN MIT SUPER DETAILS



Gedeckter Güterwagen Gmrs30 der DB
Betriebs-Nr. 235 008

Best.-Nr. **50745** 112,6

LIEFERTERMIN: Q4/2023

UVP* 47,90 EUR

- Metallachslager
- Drehgestell mit Dreipunktlagerung
- Vorbildgerechter Rahmenaufbau
- Extra angesetzte Achslagerdeckel
- Bremsbacken in Radebene
- Extra angesetzte Griffstangen und Tritte
- Extra angesetztes Achsbremsgestänge
- Extra angesetzte Bremsanlage
- Durchbrochene Wagenkastenstütze

Leichtbaukesselwagen Uerdingen SCwf 2-achsig „Paul Millet“ der SNCF
Betriebs-Nr. 595 447 [P]

Best.-Nr. **50054** 101,1

LIEFERBAR

UVP* 42,50 EUR

Leichtbaukesselwagen Uerdingen 2-achsig „BASF“ der DB
Betriebs-Nr. 21 80 001 5 473-0 [P]

Best.-Nr. **50052** 101,1

LIEFERBAR

UVP* 42,50 EUR





DIE PRINTE – EINE DELIKATESSE VON LAMBERTZ

Weit über die Stadt- und Landesgrenze hinaus, erfreut sich die „Lambertz'sche Printe“ hoher Beliebtheit. Die Geschichte des knusprigen Gebäcks geht zurück bis auf das Jahr 1688 als in der Aachener Sonnenstraße eine kleine Bäckerei gegründet wurde. Heute vertreibt das Traditions- und Familienunternehmen seine diversen Gebäcke weltweit und ist Weltmarktführer bei Herbst- und Weihnachtsgebäck.

Der unvergleichliche Geschmack der Printen wird durch edle Gewürze wie Nelken, Kardamon und Koriander gewonnen. Als die Tochter von Henry Lambetz durch Zufall ihre traditionelle Kräuterprinte in Schokolade taucht, entsteht das erste deutsche Gebäck mit Schokoladenüberzug – die äußerst beliebte Schokoladenprinte. Erweitert wird die Produktpalette im Jahr 1938 durch die Herstellung der Saftprinte.



© LAMBERTZ



LIMITIERTES SONDERMODELL „WEIHNACHTEN 2023“



Gedeckter Güterwagen G10 "Lambertz" der DB
Betriebs-Nr. 125 627

Best.-Nr. **49867**



107,2



LIEFERTERMIN: Q4/2023

UVP* 45,90 EUR

- Vorbildgerechter Rahmenaufbau
- Präzise Nachbildung der Bretterfugen
- Achsstege und Räder aus Metall
- Mehrteilige Bremsanlage
- Extra angesetzte Signalhalter

- Bremsbacken in Radebene
- Durchbrochene Wagenkastenstützen
- Präzise Bedruckung und Lackierung
- Extra angesetzte Achslagerdeckel



BEQUEMER SERVICE AUF DER BRAWA WEBSITE

ERSATZTEILE BESTELLEN

www.brawa.de/ersatzteilservice

FAQ – HÄUFIG GESTELLTE FRAGEN

www.brawa.de/faq

WWW.BRAWA.DE

*Unverbindliche Preisempfehlung (inkl. 19 % MwSt.), Preisänderungen vorbehalten.
Konstruktions- oder Formänderungen, Abweichungen im Farbton bleiben vorbehalten.

BASF, Bautz'ner, Deutsche Post, IFA, Julius Meinel, Kaiser Bier, Lambertz, Leuna, Paul Millet,
Rei und Westfalia sind eingetragene Warenzeichen.

BRAWA Artur Braun Modellspielwarenfabrik GmbH & Co. KG Uferstraße 24–30 D-73630 Remshalden
Hotline: Montag–Donnerstag 13.00 bis 15.00 Uhr +49 7151 97935-68
Fax +49 7151 74662 info@brawa.de www.brawa.de

